

**system**  
FIDELITY



# INSTRUCTION MANUALS

## RS-250 FM/AM STEREO RECEIVER

# CONTENTS

ACCESSORIES	3
CONTENTS	3
SAFETY PRECAUTIONS	4
IMPORTANT SAFETY INSTRUCTIONS	4
IMPORTANT INFORMATION	7
CONNECTIONS TO THE MAINS	8
REMOTE CONTROL	8
FRONT/REAR PANEL	10
AUDIO CONNECTIONS	11
OPERATION AND FUNCTIONS	12
ON, OFF and Standby	
Selecting the input source	
Using the function menu	
Volume control	
Bass and treble control	
Balance control	
Loudness	
RDS and FM/AM	
ABOUT THE ANTENNA	15
TROUBLESHOOTING	16
TECHNICAL DATA	17

# ACCESSORIES

## Accessories

- 1 x RS-250 FM/AM Stereo Receiver
- 1 x Remote control
- 2 x Batteries
- 1 x Operation Manual

*This operation manual supplies all the information that you need to have about your System Fidelity FM/AM Stereo Receiver. Please read this operation manual carefully before you start using the unit!*

## SAFETY PRECAUTIONS



A triangle with a lightning symbol draws the user's attention to "dangerous voltage" without insulation in the cabinet which may be high enough to entail a risk of electric shock.



A triangle with an exclamation mark draws the user's attention to important instructions for use and maintenance in the accompanying manual, which should be studied.



A symbol for CLASS II (double insulation)

### WARNING:

TO MINIMISE THE RISK OF FIRE OR ELECTRICAL SHOCK, DO NOT EXPOSE THE UNIT TO RAIN OR MOISTURE. DO NOT OPEN THE CABINET AS IT CONTAINS DANGEROUS VOLTAGE. ONLY QUALIFIED TECHNICIANS ARE ALLOWED TO CARRY OUT REPAIR AND SERVICE.

### CAUTION:

If the plug of the power cord needs to be replaced, it is important that the replacement is identical to the plug to be replaced, or that the new plug has been recommended by the manufacturer.

TO AVOID ELECTRICAL SHOCK, IT IS IMPORTANT TO INSERT THE PLUG CORRECTLY INTO THE SOCKET.

## IMPORTANT SAFETY INSTRUCTIONS

**WARNING:** IT IS IMPORTANT THAT YOU READ AND OBSERVE BOTH THE INSTRUCTIONS IN THIS MANUAL AND THE INSTRUCTIONS ON THE UNIT. KEEP THIS MANUAL FOR FUTURE REFERENCE .

This unit was designed and manufactured with a view to providing maximum safety for the user. Incorrect use of the unit may cause electrical shock or fire. The protection devices built into this unit will protect the user if the procedures below are observed in connection with installation, use and repair. This unit is fully electronic and contains no parts that can be repaired by the end user .

PLEASE DO NOT REMOVE THE CABINET. RISK OF DANGEROUS VOLTAGE. ONLY QUALIFIED AND AUTHORIZED TECHNICIANS ARE ALLOWED TO REPAIR THE UNIT.

### Read the manual upon unpacking the unit

Please read the manual carefully and observe all the instructions given.

### Power supply

Only the power supply indicated on the rating plate must be used for this unit.

If you are not sure which power supply you have, please contact the distributor or the local electricity supplier.

### Earthing or polarisation

If the plug cannot be inserted properly into the socket, or if the plug does not fit, the unit must not be used in your country.

## **Ventilation**

The cabinet is provided with slots and openings to ensure ventilation and reliable operation and to protect the unit against overheating. Do not block or cover these openings. The openings must never be blocked, for instance by placing the unit on a bed, a sofa, a carpet or similar surface .

## **Heat**

Do not place the unit near sources of heat such as radiators, heat registers, ovens or other units that produce heat.

## **Water and moisture**

The unit must not be placed close to water, such as bathtub, wash basin, kitchen sink or laundry tub, in a damp cellar or close to a swimming pools, etc.

## **Cleaning**

Unplug the unit before cleaning. Do not use liquid detergents and aerosol cleaning agents. Please use only a dry cloth for cleaning the unit.

## **Power cords**

Wiring must be organised to prevent people from stepping on the cables and to avoid pinching by objects placed on or beside them. Take special care around sockets and plug boxes and where the power cords leave the unit.

## **Overloading**

Make sure that wall sockets, extension cords and plug boxes are not overloaded as this may lead to fire or electrical shock.

## **Lightning**

Unplug the unit for additional protection during thunderstorms or when the unit is not used for prolonged periods. This will prevent damage to the unit from lightning and power surges.

## **Penetration of objects and liquid**

Never push any foreign objects through the openings into the unit, as they may touch dangerous voltage points or short-circuit parts and thus cause fire or electric shock. Do not allow any liquid to be spilled on or into the unit.

## **Accessories**

Do not place the unit on unstable surfaces such as a trolley, stand, tripod, shelf or table. The unit may fall and injure children or adults or be seriously damaged. Use only trolley, stand, tripod, shelf or table that is very stable or provided with the unit. The unit must be installed in accordance with the manufacturers instructions and by means of installation equipment recommended by the manufacturer.

If the unit is placed on a trolley, the trolley must be moved very carefully. Sudden stops, unnecessary force and uneven surfaces may cause the trolley to turn over.

## **Loads**

Do not place heavy loads on the unit and do not step on it. The load may fall and cause serious injury to persons or damage to the unit.

## **Damage**

Unplug the unit and contact qualified technicians in the following cases:

- A) If the power cord or the plug is damaged.
- B) If liquid has been spilled on the unit or objects have fallen into the unit.
- C) If the unit has been exposed to rain or water.
- D) If the unit does not work properly after adhering to the instructions in the operation manual. Only the settings described in the operation manual

must be made as incorrect setting may result in damage and often will make it difficult for a qualified technician to make the unit work properly again.

E) If the unit has been dropped or damaged in any other way.

F) When the operation of the unit changes drastically, the unit requires service.

**Service**

Do not attempt to carry out any service work yourself. By opening or removing the cabinet, you will be exposed to dangerous voltage or other hazards. Any service work should be carried out by qualified technicians.

**Spare parts**

If spare parts are required, make sure that the service technician uses spare parts specified by the manufacturer or spare parts with the same characteristics as the original. Unauthorised spare parts may cause fire, electrical shock, etc.

**Safety check**

After service or repairs on the unit, ask the service technician to carry out a safety check to ensure that the unit is ready for use.

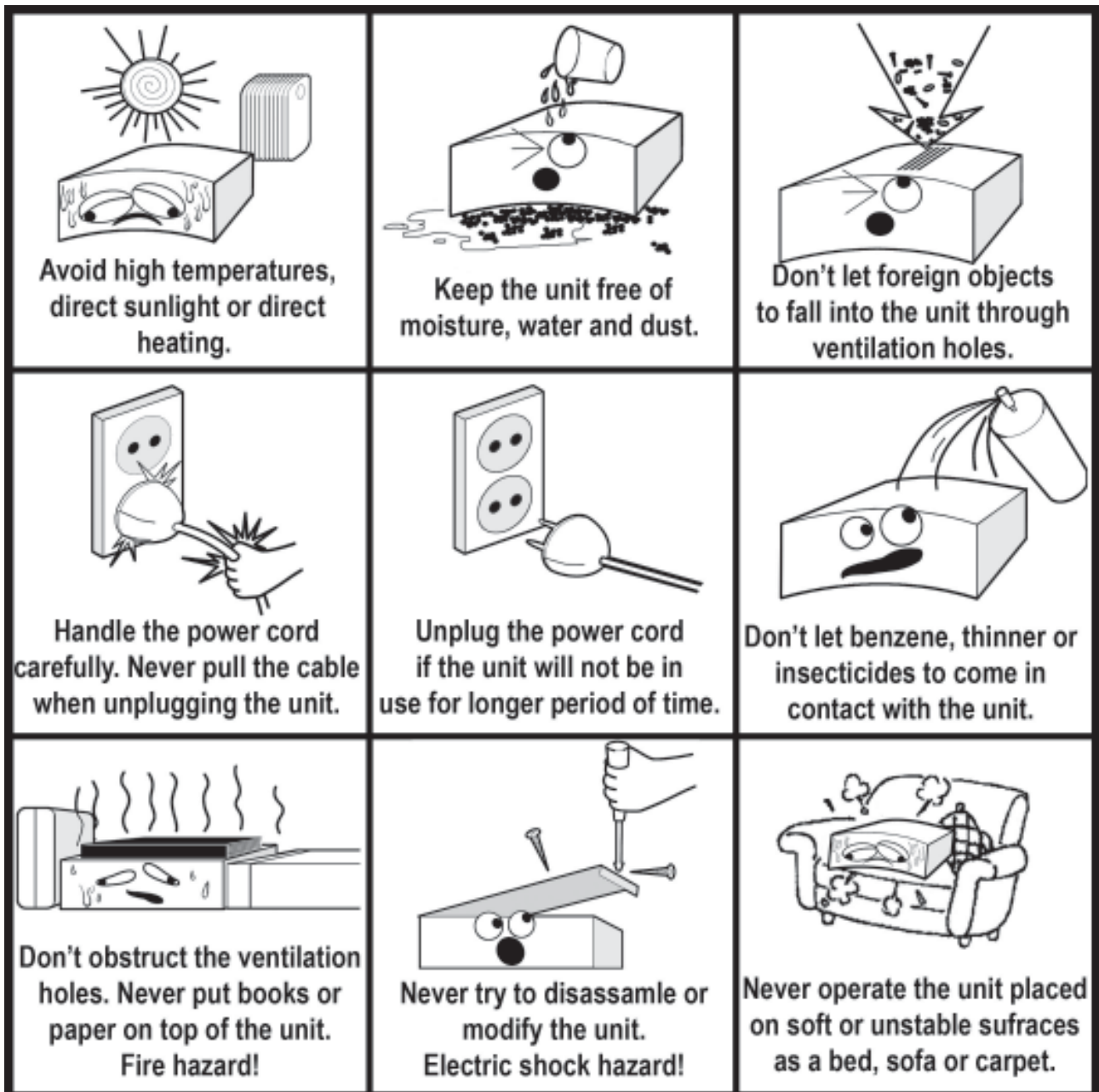

## IMPORTANT INFORMATION

### Handling instructions

The top and back panel of the unit may become warm after prolonged use. This is not due to a defect.

Turn off the power when the unit is not used.

### Protect the power cord

Follow the instructions below to prevent abnormal operation, electrical shock, fire or personal injury: Hold the plug firmly when inserting it into the socket.

Avoid heat-producing devices.

Do not place objects on the power cord.

Do not carry out service work on or change the power cord.

### Positioning

Do not place the unit in any of the following places:

- In sunlight, close to heat-producing devices or in an enclosed rack;
- In places with high temperatures (40C or more) or high relative humidity (90% or more);
- In dirty or dusty places as some internal parts may be damaged.

### Please do not put your fingers or any other objects into the unit

Touching the internal parts is dangerous and may cause injury or damage. Do not open the cabinet. Do not place any foreign matter in the unit.

### Interference

Placing the amplifier near a television set, radio or video player may cause poor picture and sound quality. In that case, move the amplifier further away from the television set, radio or video player.

### Condensation

Condensation may occur in the following cases:

When the amplifier is moved directly from a cold to a warm place.

When the amplifier is used in a room where the radiator has just been switched on or a place where the cold air from the air-conditioning system is directed at the unit.

If the amplifier is used in the summer in a warm and humid room just after it has been moved from an air-conditioned room.

If there is steam or a high level of humidity in the room.

In case of condensation, the amplifier will not work properly. Turn off the unit. Unplug the unit and leave it for 2-3 hours. The amplifier will then have adapted to the environment and any condensation will have disappeared.

### NOTES ON INSTALLATION

Your System Fidelity RS-250 should be placed on a firm, level surface. Avoid placing it in direct sunlight or near sources of heat and damp. Always allow adequate ventilation and don't place it on a soft surface like a carpet. Don't place it in an enclosed position such a bookcase or cabinet that may impede the air-flow through the ventilation holes. The unit shall not be exposed to dripping or splashing and that no objects filled with liquids, such as vases, shall be placed on the unit.

## About connection to the mains

Do not turn on the power before all connections have been made correctly.

Check that all connections have been made correctly before turning on the power.

Check that the mains voltage is 230-240V AC50Hz before turning on the power.

Check that all other connections have been made correctly before inserting the mains plug into the wall socket.

Then insert the plug into a suitable socket.

If the unit is to be used abroad, you may need an adapter.

## REMOTE CONTROL

### Installation of batteries

Remove the cover at the back.

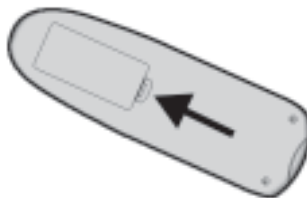

Position two batteries of the type AAA/R03/UM4 in the battery compartment. Make sure that the orientation of the batteries is correct (see drawing at bottom).

Do not mix new and old batteries and do not use different types of batteries.

If the remote control is not used for prolonged periods, remove the batteries from the remote control to avoid corrosion.

### Using the remote control

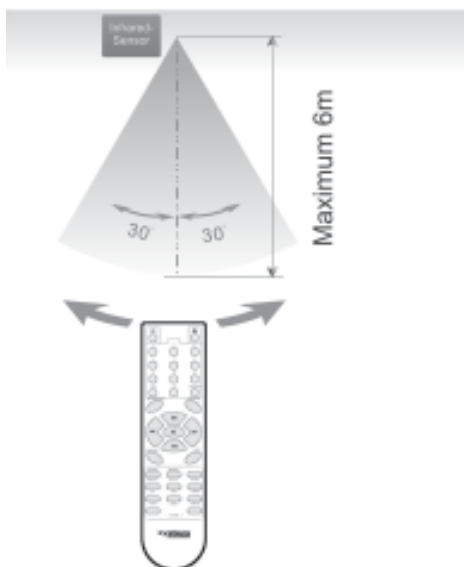

Direct the remote control at the sensor on the front panel of the amplifier. When the remote control signal is received, the unit reacts accordingly. The remote control works within a range of 6m.

Sometimes the remote control may not work well in direct strong light. You may have to move the amplifier if it is a problem.

Malfunction may occur if remote controls of some other equipments are used near the amplifier.

Do not place any objects on the remote control, as the batteries may become flat if a key is depressed constantly.

Make sure that there are no obstacles between remote control and amplifier.

Do not position the amplifier behind tinted glass as it may reduce the maximum range of the remote control.

# Remote control functions

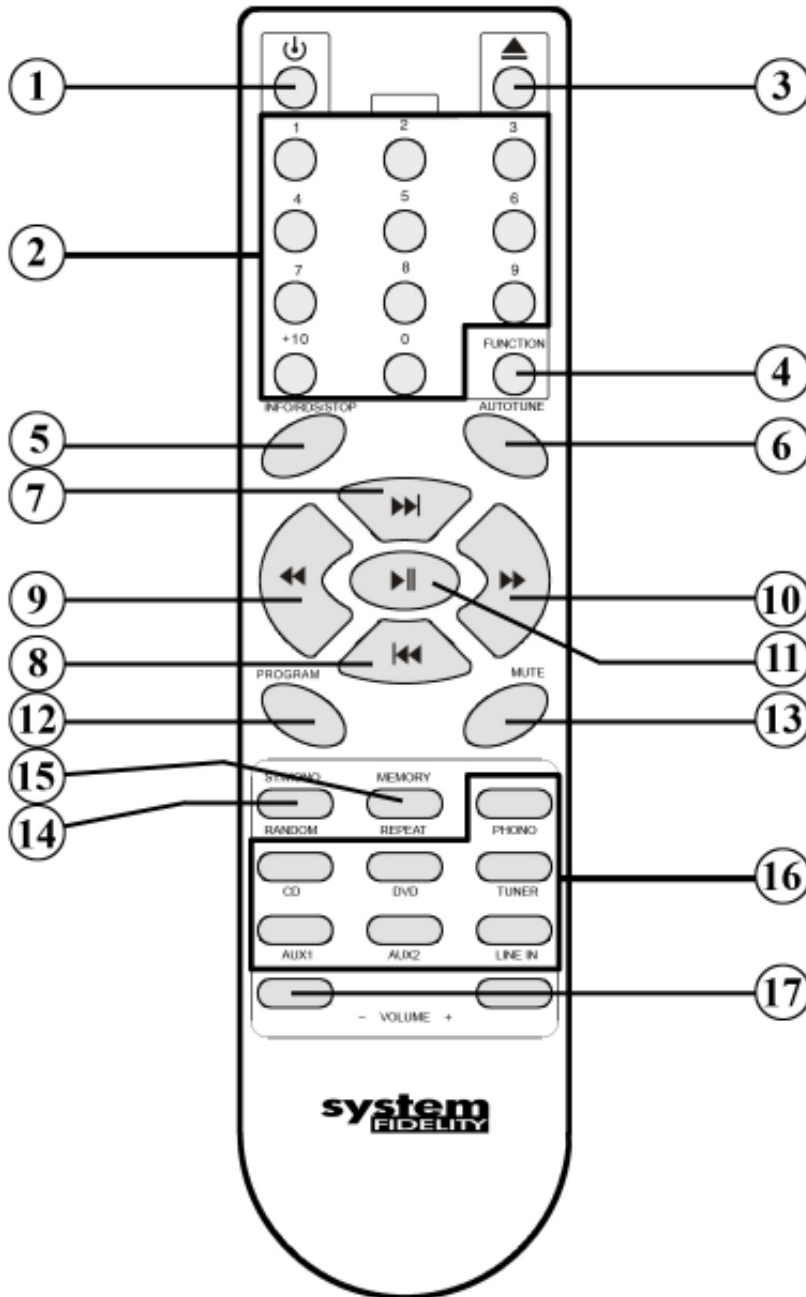

## RS-250

### AM/FM TUNER FUNCTIONS:

(2) 1-10 : Selects stored stations. If depressed for more than two seconds, a station is stored under the number concerned.

(1) Power: Sets the RS-250 in standby mode.

(6) Autotune: Press once to automatic tune in to AM/FM stations. Depress button for two seconds to initiate an automatic search. At FM, the autotune function will search for a station at a higher frequency.

(5) Info: Displays RDS and other information.

### AMPLIFIER FUNCTIONS:

(16) Input buttons: Selects input source of amplifier.

(4) Function: Adjusts treble/bass level and balance by means of VOL + and -.

(17) Volume +/-: Adjusts the master volume.

## CD-250

### CD-PLAYER FUNCTIONS:

(2) 1-10 : Selects desired track for playback

(3) Eject: Opens the CD tray.

(12) Program: Allows playback of the music tracks on a CD in a certain order.

(5) Stop: Stops playback.

(8) Previous: Selects the previous track.

(7) Next: Selects the next track.

(9) Search back

(10) Search forward

(11) Play/Pause: Starts and pauses playback.

(15) Repeat: Repeats a single track or all tracks on a CD.

(1) Power: Sets the CD-250 in standby mode.

(14) Random: All tracks are played in random order.

*Some of the amplifier functions can only be performed by means of the remote control. Some functions are connected with the selected signal input source. Some buttons on the remote control may therefore not be available if the corresponding signal input source has not been selected.*



## FRONT PANEL DESCRIPTION

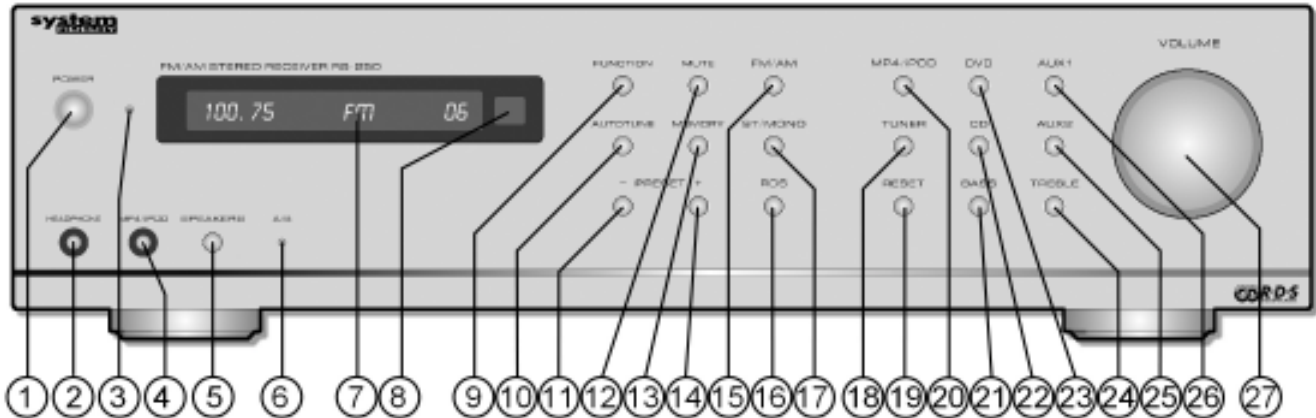

- (1) Mains switch: Used to switch on and off the unit by switching the mains voltage.
- (2) Headphone output jack: 3,5-mm jack that suits most headphones.
- (3) LED indicator: Lights blue indicating that the receiver is on stand-by mode. Switched off when the receiver is in operation and the LCD display is lit.
- (4) MP4/iPod input: 3,5mm jack for connection of iPod or MP3 and MP4 player.
- (5) Speakers: activates the loudspeakers A or B pair.
- (6) LED indicator for switching between A or B speaker pair.
- (7) LCD display: main display displaying most of the function performed.
- (8) IR Receiver.
- (9) Function: Gives the user access to the adjustment of the features as Balance and Loudness.
- (10) Autotune: Press this button once and the tuner will start automatically to tune and store all available stations.
- (11) Preset -: Changes down in presets.
- (12) Mute: switching the mute button mutes the sound loudness for -20dB.
- (13) Memory: After manually tuning in station, press this button once and the tuned in channel will be stored on the current preset.
- (14) Preset +: Changes up in presets.
- (15) FM/AM: Switches between FM and AM.
- (16) RDS: Activates Radio Data System
- (17) ST/Mono: Changes between stereo and mono on the FM band.
- (18) Tuner: Activates the Tuner input.
- (19) Reset: Gives the user the possibility to reset all adjustments to a factory default
- (20) MP4/iPod: Activates the MP4/iPod input
- (21) Bass: Gives the user access to the adjustment of the bass frequencies.
- (22) CD: Activates the CD input.
- (23) DVD: Activates the DVD input.
- (24) Treble: Gives the user access to the adjustment of the high tone frequencies.
- (25) AUX 2: Activates the AUX 2 input.
- (26) AUX 1: Activates the AUX 1 input.
- (27) Volume knob: By turning the knob sound volume increases or decreases

## REAR PANEL DESCRIPTION

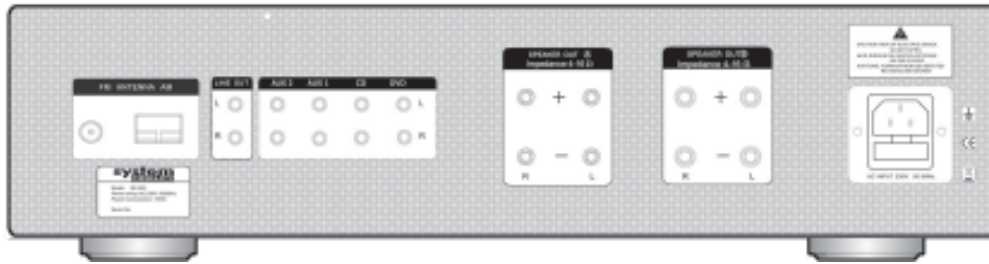

**DVD:** RCA cynch input for connection of DVD player (Note: Analogue stereo input only).

**CD:** RCA cynch input for connection of CD player.

**AUX 1:** RCA cynch input for connection of optional equipment.

**AUX 2:** RCA cynch input for connection of optional equipment.

**Speaker out A and B (left and right):** For connection of two pairs of loudspeakers.

**AC input:** For connection of mains voltage. Make sure that the plug is correctly inserted, and that the voltage corresponds to the text printed on the cabinet back panel.

**Antena:** For connection of FM or AM antenna or for the communal or cable antenna system.

## CONNECTIONS

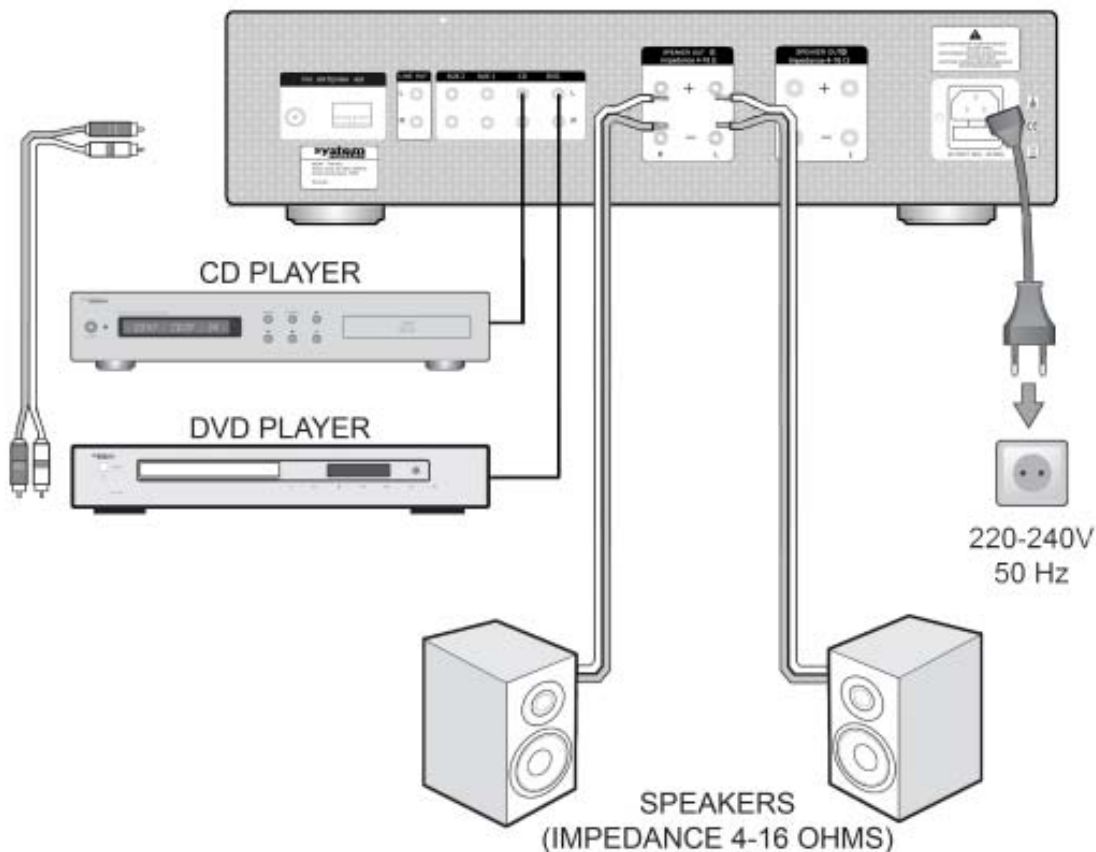

### Notes:

- The speaker impedance must be between 4 and 16 Ohm.
  - For optimal sound quality there must be a proper and firm connection between the speaker terminals and the amplifier terminals. Ensure that all cables and sockets are not damaged in any way and all sockets are firmly pushed home.
  - The cable ends must not be frayed to avoid that they come into contact with each other or the cabinet back panel. Be sure to connect the polarities of the speaker system and the speaker terminals correctly, pair A on Speaker Out A and pair B on Speaker Out B (+ to +, - to -).
  - When make the connection, please refer to the connection diagram. Make sure that all the units are switched off during any connection. The RCA sockets on your RS-250 are color coded for your convenience. Red and white are RIGHT and LEFT audio respectively.
- Use high quality RCA-interconnect and speaker cables for optimum performance and reliability.

## OPERATION AND FUNCTIONS

### Quick start

1. Connect the speakers to the speaker terminals and sources to the relevant terminals and rear input sockets on the back panel of the unit.
2. Plug in the AC power cord.
3. Press the POWER switch on the front panel of the unit to turn on the amplifier.
4. Press the required input selector. And enjoy.

### On, Off and standby

1. Turn on the amplifier by pressing the mains switch.
2. Press the standby button on the remote control to switch to standby mode. The display will turn off and all functions will be reduced to a minimum to make sure that the amplifier uses minimal power. When in standby mode the unit only reacts to the standby button of the remote control.
3. If you wish to turn off the unit to avoid any power consumption, you must press the mains switch.

*Protect the environment and turn off the unit after use.*

### Selecting the input source

Turn on the RS-250.

Now you can call the input source that is active at the moment. Select Tuner to listen to the radio, CD to listen to a CD, DVD, Phono, MP4/iPod, AUX1 or AUX2 if units have been connected to these inputs.

If you do not know which input has been selected, the LCD display will clearly indicate it.

Press the DVD, CD, Tuner, MP4/iPod, AUX 1 or AUX 2 button either on the remote control or on the front panel to select the corresponding input.

**Note:** *All inputs are analogue stereo inputs. It means that you cannot connect a digital sound source through a digital cable (optical or coaxial).*

### Using the function menu

The RS-250 features a "function menu" that allows adjustment of the following: Master volume, bass, treble, balance and loudness.

### Volume control

Turn the volume control knob to the right to increase the volume and turn the volume control to the left to reduce the volume.

The volume control on the front panel can be turned both clockwise and anticlockwise to change the volume. The volume control includes 64 steps, from -78,75 dB for minimum volume and up to 0 dB for maximum volume.

When the volume control is operated, the first line of the display will switch from information on input source to information on volume. When the volume control is no longer operated, information on input source will be displayed again after five seconds.

**Note:** *dB is a professional term for indicating the amplitude of an audio signal where 0 dB is the maximum output. You will see that the LCD display of the unit indicates - dB up to 0 dB which is the maximum volume.*

## Bass control

This amplifier features bass control that allows adjustment of the bass level by +/- 14 dB, from 45Hz to 259Hz.

1. Press the BASS button on the front panel to activate the bass tone control.
2. Press VOL+ and VOL- to adjust the bass level.
3. If you wish to adjust the bass level through the remote control, you must press the FUNCTION button until information on bass adjustment is displayed.
4. Then turn the volume control to adjust the bass level.

**Note:** *If the bass control is not operated within five seconds, the display will return to the volume information display.*

## Treble control

This amplifier features treble control that allows adjustment of the treble level by +/- 14 dB, from 2KHz to 20KHz.

1. Press the TREBLE button on the front panel to activate the treble tone control.
2. Press VOL+ and VOL- to adjust the treble level.
3. If you wish to adjust the treble level through the remote control, you must press the FUNCTION button until information on treble adjustment is displayed.
4. Then turn the volume control to adjust the treble level.

**Note:** *If the treble control is not operated within five seconds, the display will return to the volume information display.*

**Please note that the high bass or treble boost level offered by the bass/treble control may lead to permanent damage to your loudspeakers if the high setting is used for prolonged periods**

## Balance control

This amplifier features balance control that allows adjustment of the volume of one loudspeaker at a time by +/- 38,75 dB, divided into 32 steps.

This function is used to compensate for a non-centred listening position, and makes it possible to get back the correct stereo perspective.

- Press the FUNCTION button on the front panel until information on balance control is displayed.
- Turn the volume control to adjust balance.

**Note:** *If the balance control is not operated within five seconds, the display will return to the volume information display.*

## Loudness

This amplifier features a loudness function that allows boosting of the volume of the low frequencies at low volume.

This function is active at frequencies between 20Hz and 800Hz, and the function is automatically dampened when the amplifier volume is increased. When the volume is at the maximum setting, the loudness function is completely cut out.

- Press the FUNCTION button on the front panel until information on loudness is displayed
- Turn the volume control to the right to activate the loudness function and to the left to deactivate the loudness function.

**Note:** *If the loudness function is not operated within five seconds, the display will return to the volume information display.*

## RDS and FM/AM

1. As the tuner can receive both normal FM radio and AM, it features a function that can switch between the two reception types. To switch between FM and AM, you must either press the FM/AM button on the front panel or the FM or AM buttons on the remote control.

2. The tuner features information possibilities on FM called RDS (Radio Data System). RDS is a method for the transmission of additional information from local Radio Stations. It can only operated in FM mode. For example, name of the station broadcasting, name of the program or the type of program will be shown on the multi-function display.

To activate this information, press "RDS" on remote control, there are functions for PS, PTY, WAIT CT and RT.

### PS (Program Service Name)

Press "RDS" on remote control until "PS" appears. The current station name will be shown.

**Note:** "NO PS" will be shown if the signal from local radio station is not strong enough or no such service is available at the chosen station.

### PTY (Program Type)

Press "RDS" on remote control until "PTY" appears. The current name type of the program will be shown.

**Note:** "NO PTY" will be shown if the signal from local radio station is not strong enough or no such service is available at the chosen station.

### CT (Clock - Time)

Press "RDS" on remote control, then "WAITING CT" will appear. The current time from Radio Station will be shown, e.g. 15:30

**Notes:** Time will be only transmitted from local radio station once a minute, so you need to wait for less than 1 minute to show the result. "NO CT" will be shown if the signal from local radio station is not strong enough or no such service is available at the chosen station.

### RT (Radio text)

Press "RDS" on remote control until "RT" appears. Some Text messages will be shown.

**Note:** "NO RT" will be shown if the signal from local radio station is not strong enough or no such service is available at the chosen station.

### PTY SEARCH (Program Type Search)

1. Press the "PTY SEARCH" on remote control, "PTY SELECT" will flash on the display.
2. Press TUNING + /- to choose the program type, for example, NEWS, SPORT, ...etc.
3. Press "PTY SEARCH" again once you choose the program type.
4. When the type of program tuned in, it will stop searching, otherwise, "NO FOUND" will appear.

## Tuning

### Automatic tuning

When the unit is turned on for the first time, all settings will be default settings. The settings can be changed according to your preference. When the unit is turned off the next time, these settings will naturally be saved as the new default settings. This also applies if you unplug the unit.

When the unit has been turned on, channels must be saved. This is done by means of the autotune function.

1. To use the autotune function through the front panel controls, press the AUTOTUNE button. All available channels on the current tuner band will be saved.
2. You can also press the AUTOTUNE button on the remote control.

**Note:** Weak stations may also be stored in memory, so manual memory presetting may be needed in order to have better receiving.

## Manual tuning

1. If you want to manual tune a channel, you must press the tune + or - button on the remote control, or turn the tuning knob on the front panel. For every push on the button, the frequency will change 0,05MHz on FM and 9 KHz on AM.

2. To store the manually tuned channel, simply press the Memory button on the front panel or the Memo button on the remote. The channel will then be stored on the current preset.

## Selecting presets

Channels that have been saved can be selected either by means of the Preset + and Preset - buttons on the remote control or on the front panel, or by the direct access buttons (1-5 on the front panel or 1-9 on the remote control).

## Stereo and Mono

In some areas not all stations can be received noise free, because it is not possible to get a strong enough antenna signal.

In this case there will be a lot of noise on some radio stations. It is possible to reduce the noise quite a bit by listening to the radio station in mono instead of in stereo. This can make the radio station acceptable to listen to. Change to mono by pressing the ST/MO button on the remote or the ST/MONO button on the front panel. To change back to stereo again, simply press the button once again.

## Reset

This unit can be reset. Press the RESET button on the front panel to reset the unit.

# ABOUT THE ANTENNA

As it applies to all other radios, the sound quality depends on the signal strength of the antenna inputs.

The position of the radio in relation to the transmitter thus directly influences the quality of the signal received. For an optimal result it is therefore very important that you make sure that the radio receives the best possible antenna signal.

The FM antenna must be adjusted for the best possible result. A good tip is to let the antenna end point in a vertical direction and fix it on a wall.

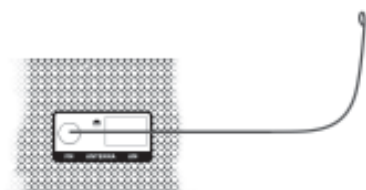

For an optimal result it is recommended to install a FM antenna on the roof or on the loft, or to connect it to a cable system.



For receiving AM station an AM loop antenna must be installed. Adjust the antenna for the best possible reception.

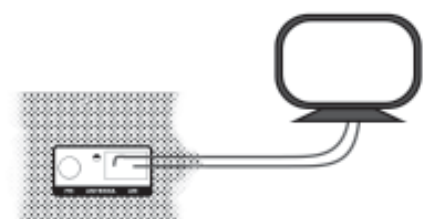

# TROUBLESHOOTING

PROBLEM	CAUSE/REMEDY
No power when the receiver is turned on.	<ul style="list-style-type: none"> <li>-Switch on the electric current at the socket.</li> <li>-Check that the plug has been correctly inserted into the socket.</li> <li>-The internal fuse has blown and must be replaced by a qualified service technician.</li> <li>-The power cord has been damaged and must be replaced</li> </ul>
No sound.	<ul style="list-style-type: none"> <li>-The receiver has not been turned on from stand-by mode.</li> <li>-The volume control is set at a minimum</li> <li>-The speaker cables have not been correctly connected.</li> <li>-A wrong input source has been selected.</li> <li>-No input source has been connected.</li> </ul>
There is sound in one channel only.	<ul style="list-style-type: none"> <li>-The balance control is not correctly adjusted</li> <li>-The audio input cables have been incorrectly connected or damaged.</li> <li>-The input source is defective.</li> <li>-The speaker cables have been incorrectly connected or damaged.</li> <li>-The speakers are defective.</li> </ul>
<p>High buzzing.</p> <p>Weak bass and poor stereo perspective</p>	<ul style="list-style-type: none"> <li>-The audio input cables have been incorrectly connected or damaged.</li> <li>-The ground cable for the record player has not been connected.</li> <li>-The record player pick-up is defective.</li> <li>-The speaker connection is out of phase. Check that the positive and negative poles have been correctly connected, both at the back of the amplifier and at the back of the speaker.</li> </ul>
Distortion of sound.	<ul style="list-style-type: none"> <li>-Some of the conductor wires of the speaker cable are in contact with each other which causes distortion.</li> <li>-Bass and treble controls are set too high in relation to speaker specifications.</li> <li>-The volume is set too high.</li> <li>-The receiver is defective and should be serviced by a qualified technician.</li> </ul>
The LCD display does not display any information.	<ul style="list-style-type: none"> <li>-The receiver is defective and should be serviced by a qualified authorized service.</li> </ul>
_ERROR 1 _ is displayed on the LCD display	<ul style="list-style-type: none"> <li>- The receiver is defective and should be serviced by a qualified authorized service.</li> </ul>
The unit does not switch between inputs	<ul style="list-style-type: none"> <li>-The receiver is defective and should be serviced by a qualified authorized service.</li> </ul>

# TECHNICAL DATA

<b>Output power:</b>		2x60 Watt att 4 Ohm 2x40 Watt att 8 Ohm
Frequency responce		10Hz to 63Khz (-3dB)
Distorsion		<0,05%
Signal-to-noise ratio		>90dB
<b>Line level inputs (CD,DVD,AUX1 , AUX2)</b>		
Input impedance		47 KOhm
Input sensitivity		200 mV
<b>Line level outputs</b>		
Output impedance:	Line out	100 KOhm
	Headphones	300 Ohm
Maximum output level:	Line out	740 mV
	Headphones	1.25 V
<b>Tonal control</b>		
Treble		+/- 14 dB
Bass		+/- 14 dB
<b>RF section:</b>		
Tuner bands:	FM	87.5-108.0MHz
	AM	522-1620KHz
Sensitivity:		-96dBm type
Presets:		40
Voltage and power consumption:		See back panel
Dimensions (WxDxH):		430x290x100 mm
Weight:		7.8 Kg

*We reserve the right to change the technical data and the design of the product without notice as a result of further development*





**system**  
**FIDELITY**

For further informations please visit our web site:

[www.systemfidelity.com](http://www.systemfidelity.com)